



IXP220 CONTROLLER

ImproX IXP220 Controller INSTALLATION MANUAL

SPECIFICATIONS

Working Environment

Open Frame Construction (ISC96X)	Designed to work in an indoor (dry) environment. The Controller is NOT sealed against water.
Power Supply Combo (IPS96X) ..	Designed to work in an indoor (dry) environment similar to IP20. The Power Supply Combo is NOT sealed against water.

Power

Open Frame Construction (ISC96X)

Power Input

Main Power Input Port.....	18 V DC to 32 V DC or 16 V AC to 24 V AC.
Battery Input Port.....	12 V DC to 14 V DC.

Typical Current Distribution

Controller	Current (mA)	Power (W)
12 V DC with no peripherals connected and relays off	90	1.08
24 V DC with no peripherals connected and relays off	60	1.4
16 V AC with no peripherals connected and relays off	70	1.1
Battery Charging	350 mA Trickle charge at 13.7 V DC maximum.	
External Readers	200 mA continuous at 5 V DC and 12 V DC maximum per port.	
Power Output Port.....	1 A continuous at 12 V DC to 14 V DC.	

Power Input Protection Over-voltage and over-current protection are provided on the Main Power Input.

NOTE: EMC emissions only apply when using the main Power Input Port.

NOTE: As an alternative to a battery, power the IXP220 using a 12 V DC uninterrupted power supply connected using the Battery Input.

NOTE: The Power Output Port provides a nominal 12 to 14 V DC at 1 A continuous current. When using the 12 V Backup Battery, the output provides up to 3 A briefly to cater for in rush currents into locks and other equipment. When using the Controller without the 12 V Backup Battery, then any load that demands more than 3 A from the Power Output Port can cause the IXP220 to protect against overload. The Controller achieves this by indefinitely entering Total Shutdown Mode. Once the overload is removed, the IXP220 resumes normal operation after a maximum of 3 seconds.

Power Supply Combo (IPS96X)

NOTE: An integrated transformer supplies power to this model IXP220 Controller. The Typical Current Distribution (page 1) for the Open Frame Construction applies.

Transformer

Input Voltage..... 230 V AC (nominal) at 50 Hz to 60 Hz.
Output Voltage 16 V AC.
Output Current 2 A maximum.

The following specifications are common to both the Open Frame Construction and the Power Supply Combo options.

Battery

Type 12 V Sealed Lead Acid, 7 Ahr (Max).
Approximate Length..... 151 mm (6 in) (Max).
Approximate Width..... 65 mm (3 in) (Max).
Approximate Height..... 99 mm (4 in) (Including the Terminals) (Max).
Charge Voltage 13.8 V DC at 350 mA (Max).

Real Time Clock (RTC) Backup Battery

Battery Type..... 1 x 3 V, CR2032, Lithium cell Battery.
Battery Life 2 Years with power OFF,
5 years with Power ON,
5 Years Storage with Battery Tab in place.

Controller Communication

USB Port..... USB Device, Type-B, female connector, 12 Mbps, USB V2.0.

Ethernet Port..... Standard Ethernet RJ45 connector. 10/100 Base T, half or full duplex.

RS232 Port	9-Way, D-type, female connector or terminal block connection.
Default Baud Rate.....	38 400.

NOTE: To achieve RS232 connection, use either the 9-way, D-type, female connector or the terminal block connection.

RS485 Controller Port

Electrical Interface.....	RS485.
Default Baud Rate.....	38 400.
Data Format	8 data bits, no parity, 1 stop bit.
Communications Protocol	ImproX Secure Communications Protocol.
Line Termination (RS485)	Provision is made for line termination.

GSM Module

Frequency	850 MHz, 900 MHz, 1800 MHz and 1900 MHz.
Power Consumption	
Minimum	0.05 W.
Operating.....	1.5 W.
Peak	7.5 W.

Terminal Communication

RS485 Terminal Port

Electrical Interface.....	RS485.
Baud Rate	38 400.
Data Format	8 data bits, no parity, 1 stop bit.
Communications Protocol	ImproX Secure Communications Protocol.
Line Termination (RS485)	Provision is made for line termination.

Reader Options

Wiegand Ports	2 Fully functional Wiegand Reader Ports.
Power Output	12 V DC and 5 V DC (selectable) at maximum 200 mA.
Modes Supported.....	Tag, Tag + PIN-code, Personal Access Code or Reason Code Mode except when the Reader Port is set to Wiegand Open Mode.
Antenna Reader Ports	2 Fully functional Antenna Reader Ports.

Relays

Relay Output	2 x Relays, Form C, each with NO, COM and NC contacts.
---------------------------	--

Contact Ratings	10 A at 28 V DC, 5 A at 220 V AC, 12 A at 120 V AC.
Operations	100 000 Minimum.

Digital Inputs

Input Types	4 x Dry Contact Digital Inputs.
Detection Resistance Range	< 2 kOhm.
Protection Range	+ 20 V continuous.

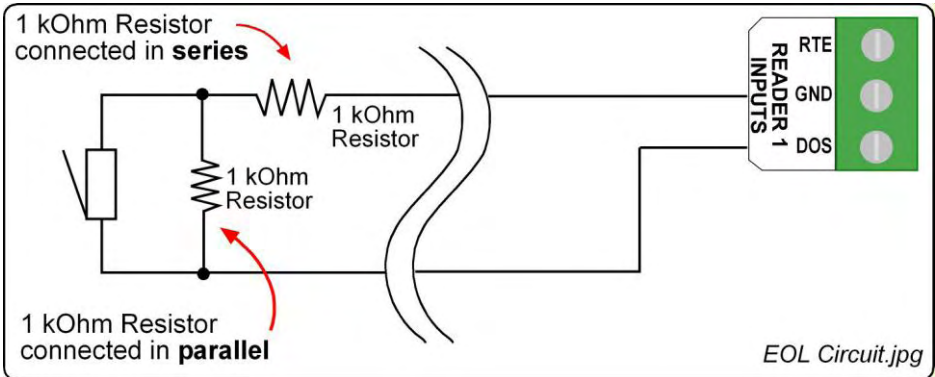

Figure 1: End of Line (EOL) Sensing Circuit

NOTE: *End of Line (EOL) Sensing enables the Controller to raise an alarm when somebody tampers with the circuit (that is, cutting or shorting the wires) between Reader 1 or Reader 2 Input (of DOS [1] or DOS [2]) and GROUND (GND). In other words the Controller distinguishes between tampering on the circuit, and the door being in an actual 'Normally Open' or 'Normally Closed' state. By placing Resistors into the circuit between the Reader 1 or Reader 2 Input (of DOS [1] or DOS [2]) and GROUND (GND), the Controller's Digital Input monitors a constant resistance through the circuit. When the circuit is tampered with, the Resistors are bypassed; the Controller detects the resistance change raising an alarm.*

NOTE: *When using the End-of-Line Sensing function, LEDs 6 and 14 will not indicate the true status of the Input.*

Alarm

Alarm Relay

Relay Output	1 x Relay, Form C, with NO, COM and NC contacts.
Contact Ratings	10 A at 28 V DC, 5 A at 220 V AC, 12 A at 120 V AC.

Alarm Signal..... IN: Dry Contact Digital Input.
 GND: Ground reference.
 OUT: Open Collector Digital Output.

General

SD Card Adapter Reserved for future use.
 Connection Standard 9-Pin SD Mode Interface, 2 GB max.

Controller Diagnostic Interfaces

Liquid Crystal Display (LCD) .. Reserved for future use.
 Characters 16 Characters by 4 lines.
 Character Sets..... English, Katakana.
 Contrast..... Adjustable using the Trimpot (see Figure 4 for location).
 Back-lighting Turned on and off via the Communications Protocol.
 Keypad Reserved for future use.
 Buttons 12 Alphanumeric and function keys.
 Back-lighting Yes.

NOTE: The LCD and Keypad back-lighting operate independently of each other.

LED Indicators

Controller Status LED Steady Red LED (internally visible).
 Incoming RS485 Data Flashing Green LED (internally visible).
 Outgoing RS485 Data Flashing Red LED (internally visible).
 Incoming RS232 Data Flashing Green LED (internally visible).
 Outgoing RS232 Data Flashing Red LED (internally visible).
 Speed LED (Ethernet) Steady Red LED (internally visible).
 Link LED (Ethernet) Steady Red LED (internally visible).
 Active LED (Ethernet) Flashing Red LED (internally visible).
 Relay LED Steady Red LED (internally visible).
 SD/MMC Active Steady Red LED (internally visible).
 USB Active Steady Red LED (internally visible).
 Digital Inputs..... Steady Green LED (internally visible).
 GSM Status LED Flashing Red LED (internally visible, only on installed GSM Module).

Antenna Reader Interfaces 2 Individual standard interfaces.

Wiegand Reader Interfaces..... 2 Standard interfaces, including 12 V DC and 5 V DC Power Outputs, 0 and 1 Data Streams, LED Control, Buzzer Control and Scanner Inhibit.

INSTALLATION INFORMATION

Accessories

Find the following when unpacking the ImproX IXP220 Controller:

- An ImproX IXP220 Controller with an open frame construction. The construction consists of a Trivalent Passivated Mild Steel Mounting Plate and a Biaxially-oriented Polypropylene Cover Plate.
- Or an ImproX IXP220 Controller housed in a Black Mild Steel, powder-coated Cabinet. The Cabinet consists of a hinged Lid and a Base.
- One copy of IXP220 Software on CD.

CAUTION: DO NOT use the Metal-oxide Varistors (25 Vrms, 500 A, 77 V max clamping) with mains power applications.

- Three Metal-oxide Varistors, 25 Vrms, 500 A, 77 V max clamping.
- A 3 V, CR2032, Lithium cell Battery.

NOTE: This Battery is partially installed all models of the IXP220 Controller.

- Four Combi Screws (No. 4 x 10 mm) (IPS96X model only).
- Four Brass Wood Screws (3.5 mm x 25 mm).
- Four Wall Plugs (7 mm).
- A MAC Address Label.
- An extra Fixed Address Label.

You will find the following when unpacking the optional extra ImproX GSM Module (GSM900-0-6-GB-XX):

- An ImproX GSM Module.

NOTE: The ImproX GSM Module does NOT include a SIM Card. Please obtain one from your preferred GPRS (Cellular) service provider.

- One GSM Quad Band Antenna with a 1 m (3 ft) cable.
- An Alcohol Prep Pad.

General

Remember the following when installing your IXP220 Controller:

Communications Distance

- The RS485 communications distance between the IXP220 Controller and the LAST Controller or Terminal in a cable run, MUST NOT exceed 1 km (1 090 yd). Achieve this using good quality screened twisted 2-pair cable, earthed on one side.
- If using Ethernet, plug the Controller into an Ethernet Switch or Hub (or other network device); cable runs must conform to Ethernet cabling specifications.
- The RS232 communications distance between the Controller and the connected Host PC MUST NOT exceed 25 m (82 ft). Achieve this by using good quality screened twisted 4-core cable.
- The USB communications distance between the Host PC and the Controller MUST NOT exceed 5 m (16 ft).

- GPRS has no minimum communications distance.

Termination Resistors for RS485 Bus Communications

Long transmission lines or multiple “star” connections, may cause communication problems. Placing the Termination Resistor Jumper Link (see Figure 4) in the LAST IXP220 CONTROLLER AT THE END OF THE CABLE RUN should solve the problem (depending on the bus).

Reader Connections

NOTE: The IXP220 Controller has three Fixed Addresses. One Fixed Address is reserved for the Controller. The other two Fixed Addresses (Terminal Addresses) allow connection of either two Antenna Readers or two Wiegand Readers.

Antenna Reader

- The specified cable distance between the IXP220 Controller and its Antenna Reader ranges between 2 m to 16 m (7 ft to 53 ft). Optimal performance is not guaranteed outside of this range. Achieve optimal performance using a good quality shielded multi-strand 3-pair twisted cable. The cable individual conductor cross-sectional area should not be less than 0.2 mm^2 (0.0003 in^2).
- Ensure that your cable specifications are similar to the following:
 - Conductor Resistance: < 2 ohms.
 - Capacitance, Core to Earth: < 160 pF/m.
 - Capacitance, Core to Core: < 100 pF/m.
- To avoid mutual interference Install dual Antenna Readers from the SAME Controller no closer than 150 mm (6 in) apart.
- To avoid mutual interference Install dual Antenna Readers from DIFFERENT Controllers no closer than 500 mm (20 in) apart.

Wiegand Reader

CAUTION: When implementing the 150 m (164 yd) cable distances with Impro Wiegand Readers use the 12 V power output option.

- For maximum, data communications distance, install the Wiegand Readers no further than 150 m (164 yd) from the Host unit. The cable individual conductor cross-sectional area should not be less than 0.2 mm^2 (0.0003 in^2).
- To avoid mutual interference, install Wiegand Readers no closer than 500 mm (20 in) apart.

EARTH Connection

Connect the IXP220 Controller to a good EARTH point. Connect the EARTH Lead to the “ETH” Terminal on the Power Input Port. Mains EARTH can be used, but electrical noise may exist.

Blank Space

Arc Suppression

Snubber devices are recommended for EMF Flyback and Arc Suppression when driving an inductive load with the Relay, see Figure 2.

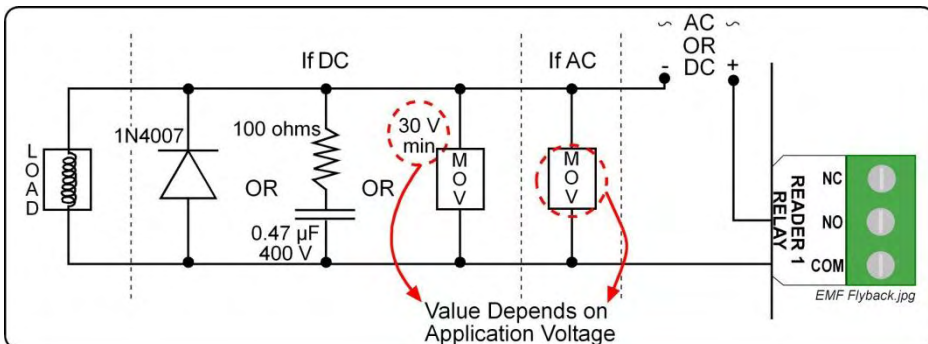

Figure 2: EMF Flyback

Installing the Real Time Clock (RTC) Backup Battery

CAUTION: Insert the supplied 3 V Lithium Battery for the Real Time Clock into the Battery Holder BEFORE powering up the IXP220 Controller.

Refer to Figure 4 for the location of the Real Time Clock Backup Battery Holder.

First Time Use

Open Frame Construction (ISC96X)

1. Ensure that power is NOT applied to the Controller.
2. Position the Controller with the Cover Plate facing upwards and the Impro logo on the right-hand side.
3. Locate the removable Battery Tab underneath the Controller's Cover Plate, in line with the Impro logo on the right-hand side.
4. Pull the removable Battery Tab out of the Battery Holder.
5. Apply power to the Controller.

Power Supply Combo (IPS96X)

1. Ensure that power is NOT applied to the Power Supply Combo.
2. Open the Cabinet.
3. Locate the removable Battery Tab in the Real Time Clock Battery Holder.
4. Pull the removable Battery Tab out of the Battery Holder.
5. Close the Cabinet.
6. Apply power to the Power Supply Combo.

Replacement

1. Access the IXP220 Controller's Printed Circuit Board (PCB):
 - For ICS96X, remove the Controller's Cover Plate.
 - For IPS96X, open the Lid of the Cabinet.
2. Remove the old 3 V, CR2032, Lithium cell Battery from the Battery Holder by pulling the plastic retaining clip AWAY from the Battery Holder. The Battery Holder is spring-loaded and will raise the Battery out of the Holder.

3. Slide the NEW 3 V, CR2032, Lithium cell Battery under the metal clip of the Battery Holder, with the "+" Terminal facing UP.
4. Pull the plastic clip away from the Battery Holder and press the Battery firmly into the Battery Holder.
5. Complete replacement by:
 - For ICS96X, replace the Controller's Cover Plate.
 - For IPS96X, close the Lid of the Cabinet.

Installing the 12 V Sealed Lead Acid Battery

Power Supply Combo

1. Open the Lid of the Cabinet.
2. Slide the Lid in an upwards direction and unhinge.
3. Place the Battery into the Cabinet with the Battery Terminals in an upwards position.
4. Connect the Red Battery Terminal Lead to the Positive Battery Terminal.
5. Connect the Black Battery Terminal Lead to the Negative Battery Terminal.
6. Re-hinge the Lid and slide it in a downwards direction.
7. Close the Lid of the Cabinet.

Installing the ImproX GSM Module (Optional Extra)

CAUTION: Connect the ImproX GSM Module BEFORE powering up the IXP220 Controller. Power down the IXP220 Controller BEFORE removing the GSM Module.

1. Insert the SIM Card as shown on the Module.
2. Access the IXP220 Controller's Printed Circuit Board (PCB):
 - For ICS96X, remove the Controller's Cover Plate.
 - For IPS96X, open the Lid of the Cabinet.
3. Locate the GSM Module Connectors (See Figure 4).
4. Plug in the GSM Module with the SIM Card Slot positioned on the right-hand side.
5. Plug the GSM Quad Band Antenna into the base of the Module.
6. Select a suitable position for the GSM Quad Band Antenna, considering accessibility and routing of wires for optimal signal strength.

CAUTION: Ensure that you locate the GSM Quad Band Antenna outside of the Power Supply Combo (IPS96X) as the metal housing interferes with the Antenna's reception.

7. Use the Alcohol Prep Pad (provided) to clean the selected area.
8. Remove the backing paper from the back of the GSM Quad Band Antenna.
9. Affix the GSM Quad Band Antenna in position.
10. Complete installation by:
 - For ICS96X, replace the Controller's Cover Plate.
 - For IPS96X, close the Lid of the Cabinet.

Mounting the Controller

CAUTION: Make certain that you mount the Controller on a vibration-free surface.

Select the mounting position of the Controller, considering accessibility, routing of wires and visibility of the externally visible LED. Secure the Controller to the mounting surface, using four suitable screws and wall plugs (supplied), nuts and bolts or rivets.

Mounting the Power Supply Combo (IPS96X)

1. Fix the Base to the wall using two of the supplied screws in the Mounting Key Holes.
2. Fix the third screw in the Mounting Slot, adjusting the position of the Base if necessary.

DIP-switch Settings

NOTE: Once the DIP-switch settings are modified reset the IXP220 Controller to acknowledge the new settings.

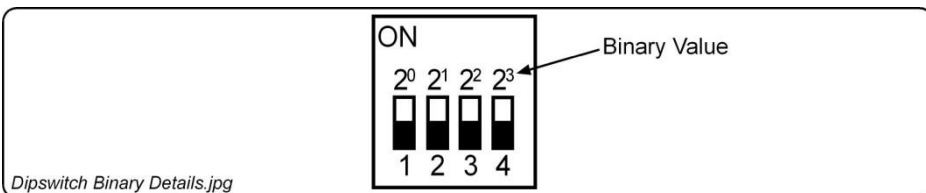



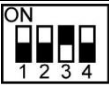



Figure 3: Binary Details for DIP-switch

Reader DIP-switch Settings

Each of the Reader Ports has a 4-way DIP-switch to select the function of that Port.

DIP-switch Position	Connections
0  DIP-switch 0 shows all the switches in the OFF position	Antenna.
1  DIP-switch 1 shows switches 2, 3 and 4 in the OFF position	Reader unused. Does not report a Fixed Address.
2 	ImproX (IR) Infrared Receiver.
3 	Magstripe.
4 	Barcode (code 3 of 9) with Checksum.
5 	Barcode (code 3 of 9) without Checksum.





DIP-switch Position	Connections
6	 <p>Wiegand 26-bit, 44-bit, 40-bit, 37-bit and Tag + PIN-code or Reason Code Mode. (Sagem MA100, MA200 or MA300).</p>
7	 <p>Wiegand Open Format.</p>
8	 <p>If the ImproX RF is connected, then Button 1 of the ImproX (QT) Quad Transmitter reports.</p>
9	 <p>If the ImproX RF is connected, then Button 2 of the ImproX (QT) Quad Transmitter reports</p>
10	 <p>If the ImproX RF is connected, then Button 3 of the ImproX (QT) Quad Transmitter reports.</p>
11	 <p>If the ImproX RF is connected, then Button 4 of the ImproX (QT) Quad Transmitter reports.</p>

Table 1: Reader DIP-switch Settings

Door Lock Select DIP-switch Settings

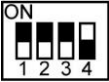

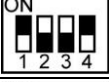

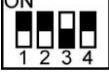

DIP-switch Position	Connections
0	 <p>No special lock control.</p>
1	 <p>Motor Lock.</p>
2	 <p>Pulse or Repeating Lock.</p>
3	 <p>Fail Safe or Fail Secure with Locked or Unlocked Status (Solenoid Lock).</p>
4	 <p>Normal Lock, no Lock or Unlock Sensors, only Emergency Mode support.</p>
5	 <p>Returns Controller to Factory Default Settings.</p> <p><i>NOTE: Return Switch 1 to the OFF position to resume normal operation.</i></p>

Table 2: Door Lock Select DIP-switch Settings

ELECTRICAL CONNECTIONS

IXP220 Controller

Key Component Positions

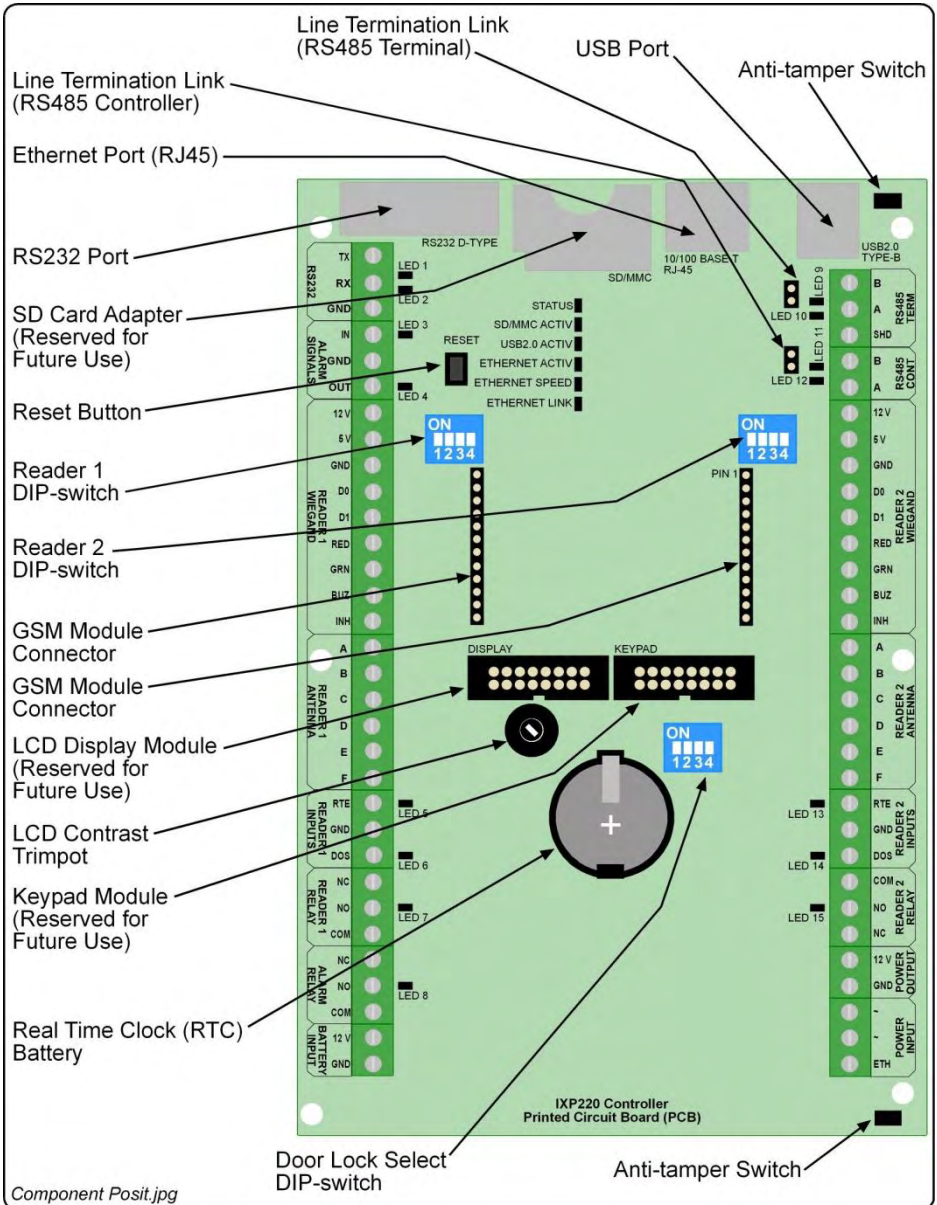

Figure 4: Key Component Positions

Power Supply Combo (IPS96X) Key Component Positions

IPS Layout Diagram.jpg

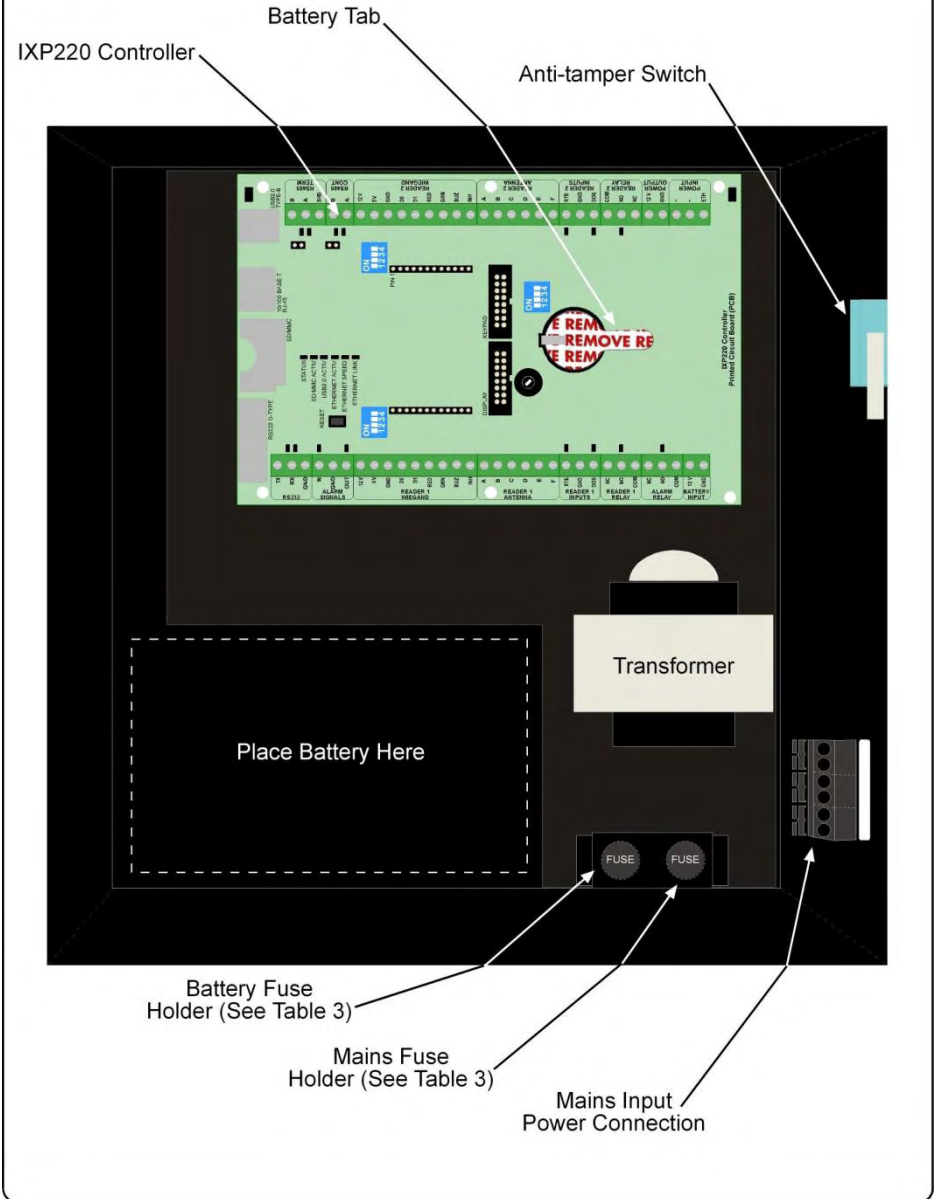

Figure 5: Power Supply Combo Layout

Electrical Connections

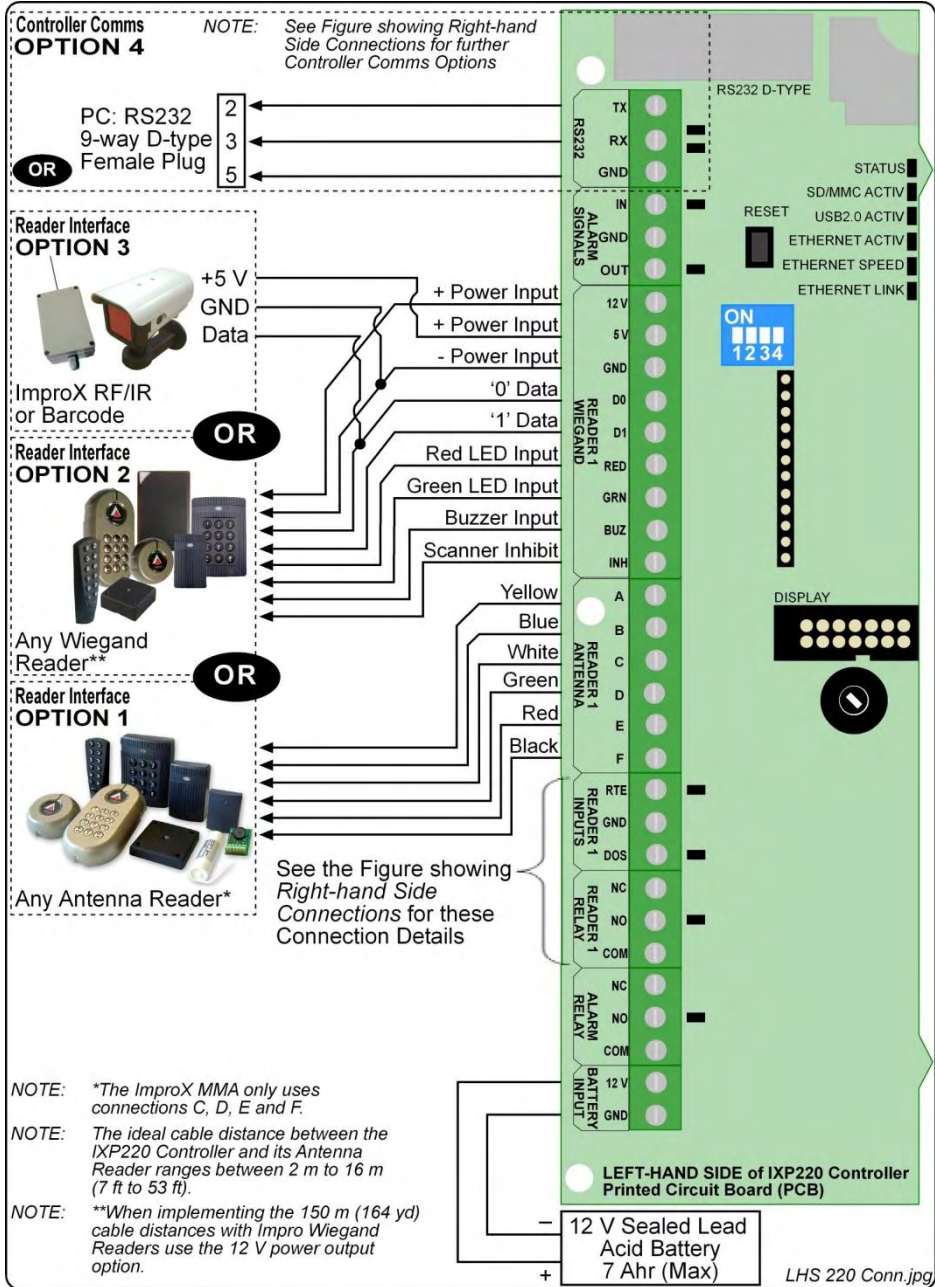

Figure 6: IXP220 Controller Left-hand Side Connection Details

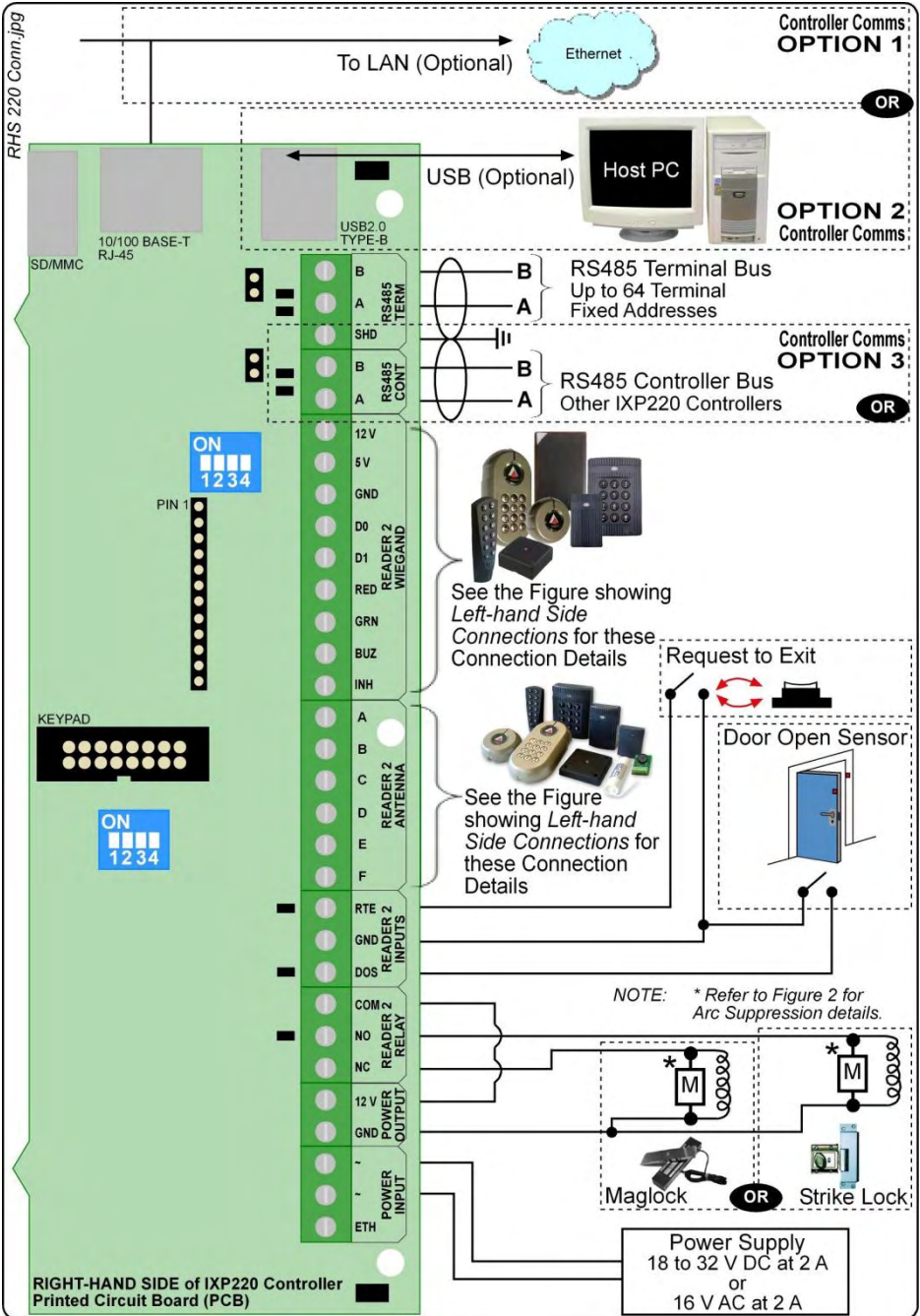

Figure 7: IXP220 Controller Right-hand Side Connection Details

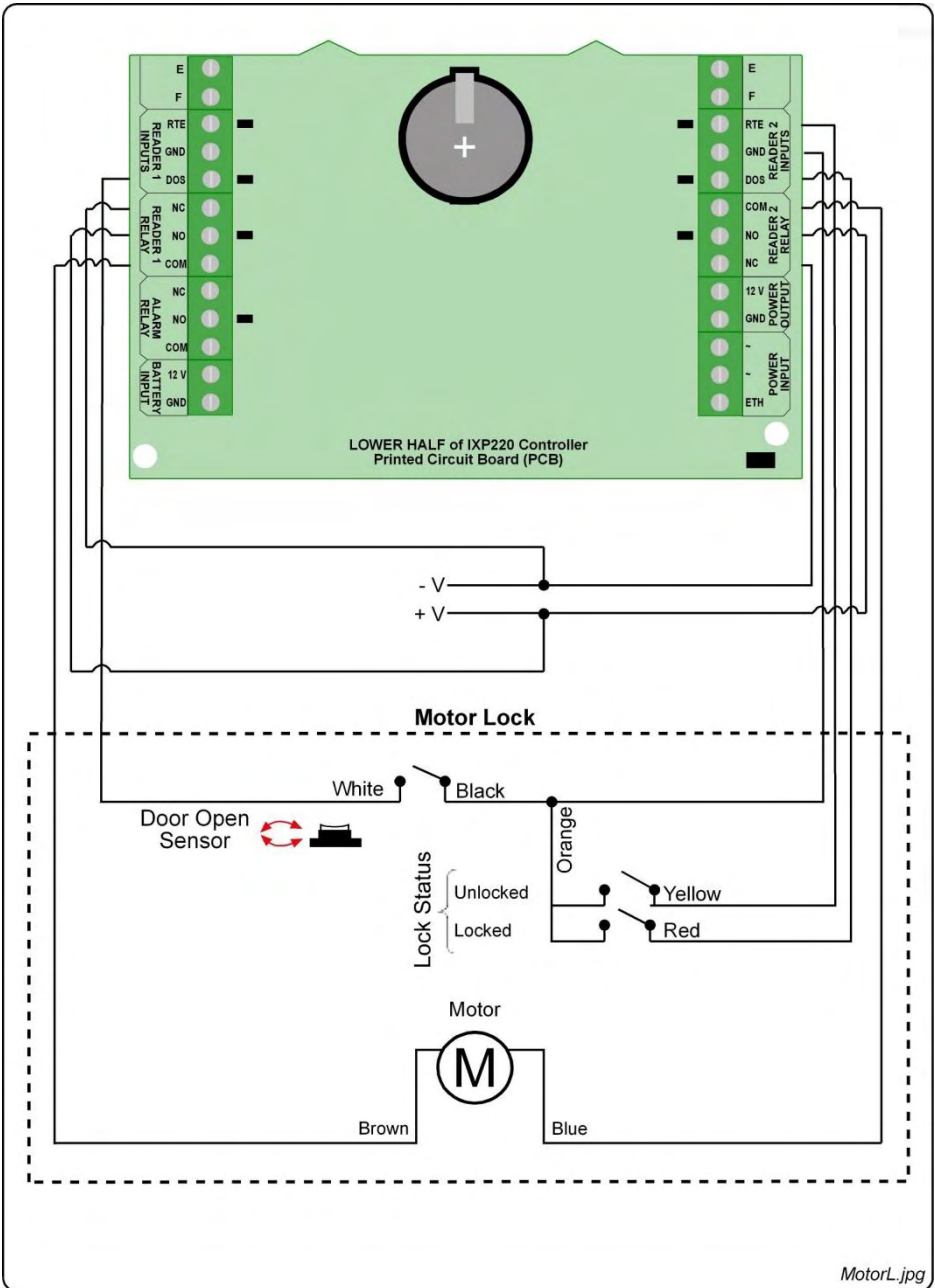

Figure 8: IXP220 Controller Connected to MIWA AL3M Motor Lock

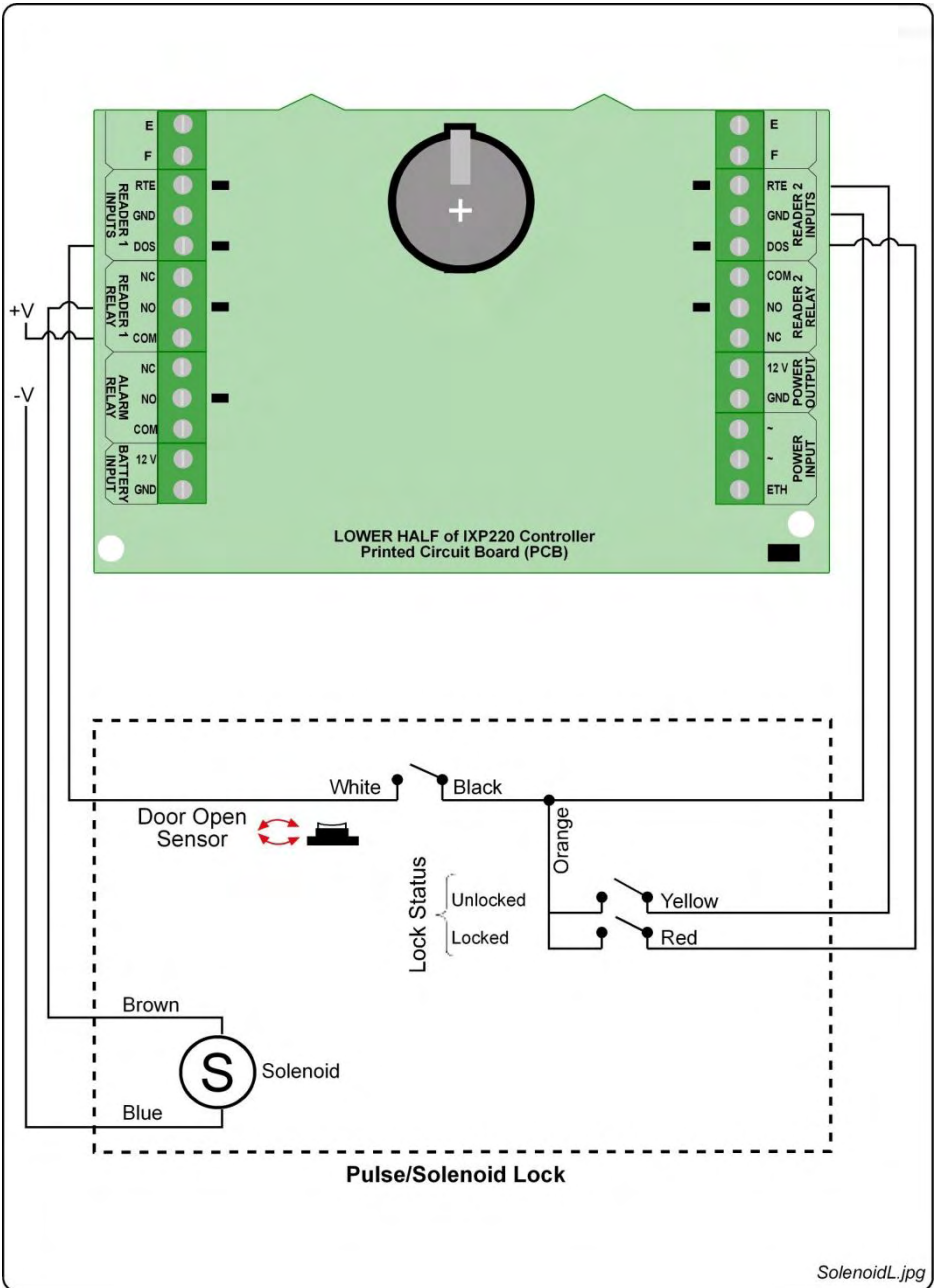

Figure 9: IXP220 Controller Connected to a Pulse or Solenoid Lock

Modes of Operation

The IXP220 System provides five “Modes of Operation”. These Modes are selected via the PC Software.

Power Control Mode

CAUTION: Refer to the Alarm Relays maximum current and voltage ratings listed under Alarm (page 4).

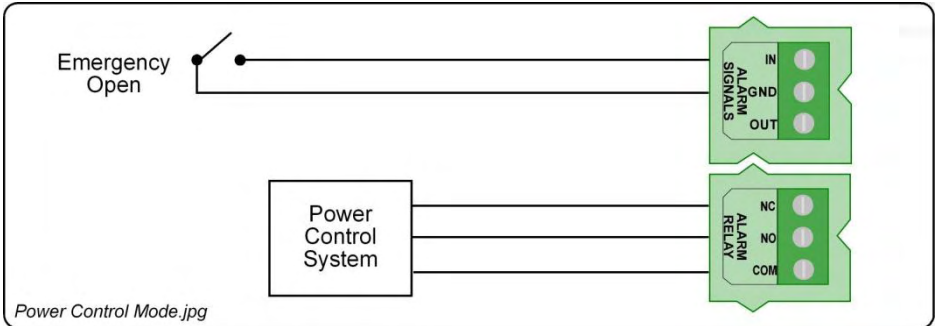

Figure 10: Power Control Mode

Power Control (Emergency) Mode

This Mode allows you to unlock all Doors (Locations) on a single Controller. That is, the “Emergency Open” input unlocks all doors in the System.

Where you have 2 Controllers with inter-controller communications, and both Controllers set to Power Control (Emergency) Mode, the unlock instruction passes from Controller 1 to Controller 2. That is, all Doors (Locations) connected to these Controllers unlock.

Power Control (Lockdown) Mode

This Mode allows you to lockdown all Doors (Locations) on a single Controller. That is, essentially denying Tagholder entry.

Where you have 2 Controllers with inter-controller communications, and both Controllers set to Power Control (Lockdown) Mode, the lockdown instruction passes from Controller 1 to Controller 2. That is, all Doors (Locations) connected to these Controllers enter lockdown.

Alarm Arming Mode

In this Mode, the Controller interfaces with an Alarm Panel to either, arm or disarm, or trigger the Alarm Panel.

Arming

1. In the IXP220 Software, designate a Reader as an “Alarm Arming Reader”, by selecting the Alarm Arm checkbox.
2. Present an Administrator or Supervisor Tag to the “Alarm Arming Reader”.
3. Press the “#” key on the Keypad Reader, within 10 seconds of presenting the Tag. The Reader beeps for 30 seconds, before activating the Alarm Relay, giving you sufficient time to vacate the Alarm Zone.

The “Armed” Input is used to detect if the Alarm Panel is armed. This Input sets the “Alarm Arming Readers” Status LED to blink, indicating that the Alarm is armed. When the System is armed, the “Alarm Arming Reader” will deny Normal or Visitor Tags access.

Disarming

Present an Administrator or Supervisor Tag to the “Alarm Arming Reader”. The Alarm Relay will deactivate, signaling the Alarm Panel to disarm.

Alarm Events

The Controller has several Events that can trigger the Alarm Panel when it is armed. These are:

- Door Forced.
- Anti-tamper.

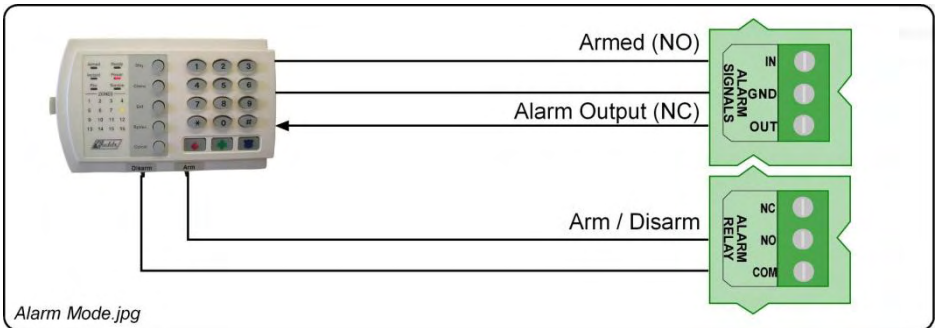

Figure 11: Alarm Mode

Intrusion Mode

In this Mode, there is no installed Alarm Panel, and a simple Alarm Sensor is required. You may connect Passive Infrared or other types of sensors to the IXP220 System’s Digital Inputs (Inputs 1 and 2). If any of these sensors trigger, the IXP220 System receives an input signal, activating Relay 3. Relay 3 then drives the siren.

Arming

1. In the IXP220 Software, designate a Reader as an “Intrusion Arming Reader”, by selecting the Alarm Arm checkbox.
2. Present an Administrator or Supervisor Tag to the “Intrusion Arming Reader”.
3. Press the “#” key on the Keypad Reader, within 10 seconds of presenting the Tag. The Reader beeps for 30 seconds, after which Intrusion Mode activates.

When the System is armed, the “Intrusion Arming Reader” will deny Normal or Visitor Tags access.

Disarming

Present an Administrator or Supervisor Tag to the “Intrusion Arming Reader”.

Blank Space

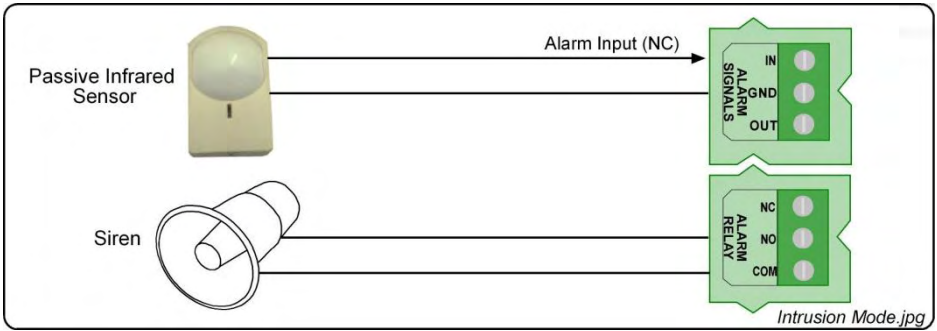

Figure 12: Intrusion Mode

Bell Button

In this mode, the Bell Button on the ImproX (KMA) Mullion Keypad Antenna Reader, when pushed, drives Relay 3 on the IXP220 Controller.

Action Mode

Use this Mode to drive Relay 3 when using the Building Management feature.

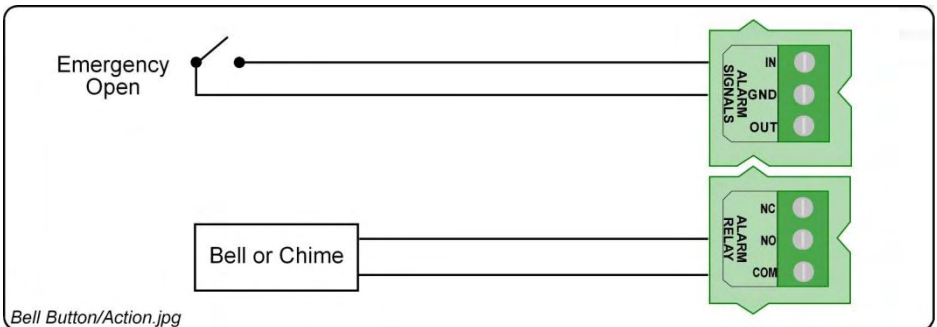

Figure 13: Bell Button and Action Mode

Blank Space

Settings Specific to the Power Supply Combo

CAUTION: DO NOT exceed the Input Voltage specified.

Use the supplied Connection Leads for the low voltage connections to the Power Supply Combo, see Figure 14. Using the supplied Quick Click Glands or Gland Breakouts, neatly lead the wires out of the Cabinet.

Wiring the Mains Input Power Cord

WARNING: DO NOT TOUCH ANY PART OF THE CIRCUIT ONCE YOU'VE APPLIED POWER TO THE POWER SUPPLY COMBO.

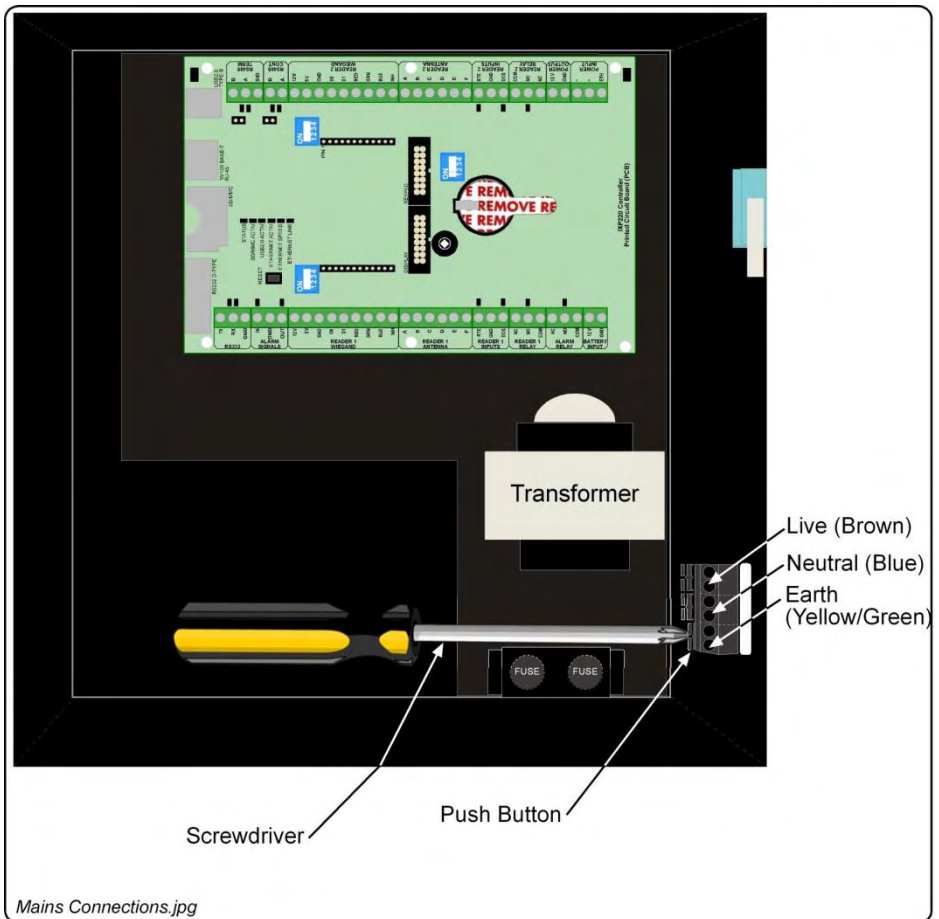

Figure 14: Mains Connections

Connect mains power as follows:

1. Using a suitable screwdriver, press and hold down the Push-button.
2. Insert the wire.
3. Release the Push-button.

4. Repeat steps 1 to 3 for each connection.
5. Attach a suitable Mains Input Power Plug using the following connections:
 - Live (Brown).
 - Neutral (Blue).
 - Earth (Yellow/Green).

Fuse Information

Fuse	Purpose	Rating
Battery Fuse	This fuse protects the Battery from overload as well as incorrect polarity connection.	3.15 A 250 V Slow-blow (5 mm x 20 mm)
Mains Fuse	This fuse protects the Power Supply Combo's mains connections from faults.	0.5 A 250 V Slow-blow (5 mm x 20 mm)

Table 3: Fuse Ratings

CAUTION: Ensure that you have disconnected the mains power supply to the Power Supply Combo, and removed the Positive Lead from the Battery before replacing the fuse.

1. Disconnect the mains power supply.
2. Open the Cabinet.
3. Disconnect the Positive Lead from the Battery.
4. Unscrew the Fuse Cap.
5. Remove the old fuse from the Fuse Cap.
6. Insert the new Fuse into the Fuse Cap.
7. Screw the Fuse Cap back into the Fuse Holder.
8. Reconnect the Positive Lead to the Battery.
9. Close the Cabinet.
10. Reconnect the mains power supply.

ADVANCED SETTINGS

The following settings are common to all the IXP220 Controller Models.

Adjusting the Liquid Crystal Display (LCD) Contrast (for future use)

Using a 2 mm flat screwdriver, adjust the Trimpot (See Figure 4 for location) as follows:

1. Remove the Controller's Cover Plate.
2. Place the tip of the screwdriver in the recess.
3. Turn the screwdriver to make your adjustment:
 - Clockwise: Text appears lighter.
 - Anti-clockwise: Text appears darker.
4. Reattach the Controller's Cover Plate.

Hardware Reset

Restart the IXP220 Controller manually, without removing the power connections, by pressing the Reset button (See Figure 4 for location).

Restoring Factory Default Settings

If you assign an invalid IP address to the Controller, it will no longer communicate. Correct this problem, by restoring the Controller's factory default settings as follows:

1. Remove the Controller's Cover Plate.
2. Set the **Door Lock Select** DIP-switch Switch 1 to the **ON** position (see Table 2, row 5 for details).
3. Press the **Reset** button (See Figure 4 for details). Alternatively, reset the Controller by removing and then reapplying the power source.
4. With the Controller running, set the **Door Lock Select** DIP-switch Switch 1 back to the **OFF** position (see Table 2, row 5 for details).
5. Reattach the Controller's Cover Plate.

UNIT ADDRESS INFORMATION

Fixed Address

Once the IXP220 Controller is installed, sketch a rough site plan. Attach the loose (additional Fixed Address Label packaged with the Controller) Fixed Address Label in the position of the Controller on the sketched site plan. When the system installation is complete and all the units are represented on the site plan by their Fixed Address Labels, file the site plan for future reference.

The Fixed Address Label included with the Controller is the Fixed Address for the Controller only. In addition to the Controller Fixed Address, the IXP220 Controller reports up to two Terminal Fixed Addresses.

- Controller's Fixed Address: 6E XX XX XX.
- Reader 1's Fixed Address: 6F XX XX XX.
- Reader 2's Fixed Address: 70 XX XX XX.

NOTE: Where additional Terminals connect to the Controller, extra Fixed Addresses for the respective Terminals appear during the Software's Auto-ID process.

MAC Address

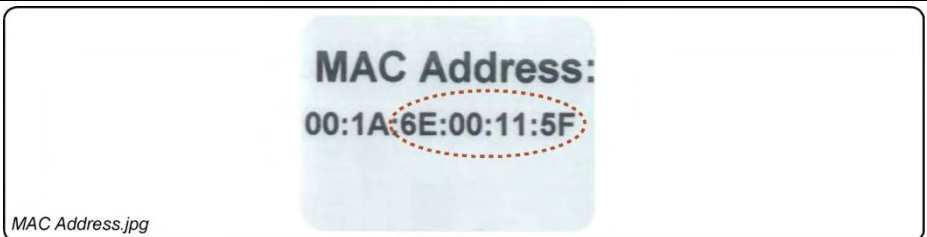

Figure 15: Sample MAC Address Label

Each IXP220 Controller is supplied with a separate MAC Address Label, much like the one shown in Figure 15, which uniquely identifies each Controller.

Attach the extra loose MAC Address Label, alongside the Fixed Address Label, to the Unit Location Chart enclosed (or your sketched site plan).

IP Address

NOTE: All ImproX IXP220 Controllers have the same IP Address (192.168.100.1). In the absence of a DHCP server, plug each Controller into the network individually and set the static IP Address.

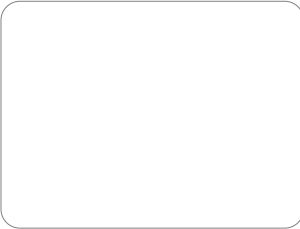
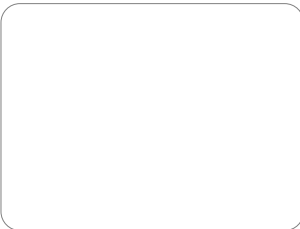

Unit Location Chart

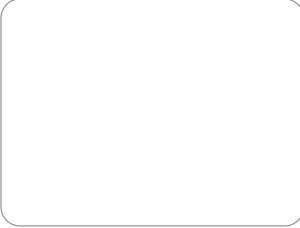
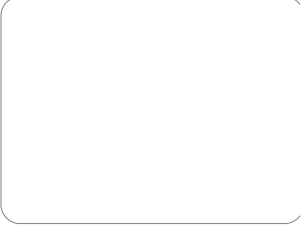
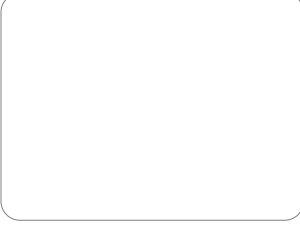
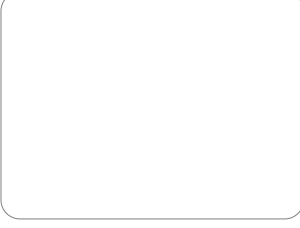
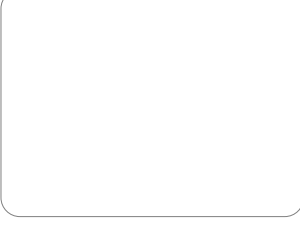
Fixed Address Label	Unique Location Description
	
	
	
	

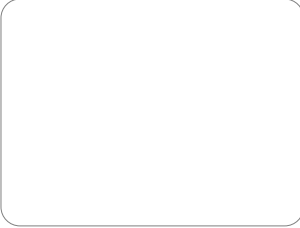
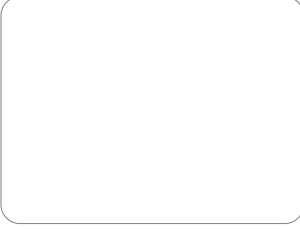
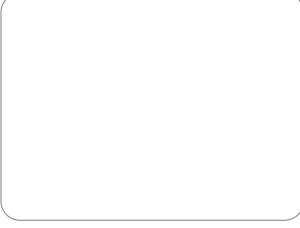
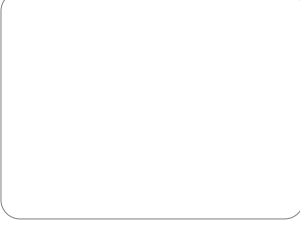
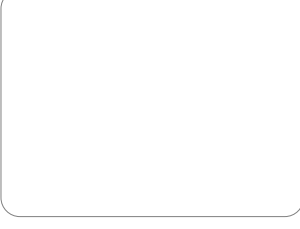
Fixed Address Label	Unique Location Description
	
	
	
	
	

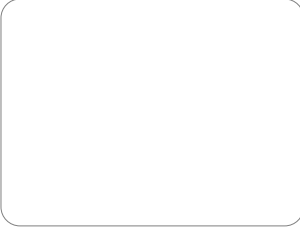
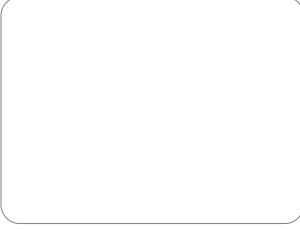
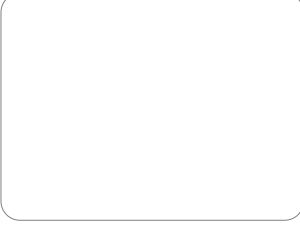
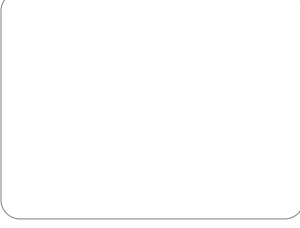
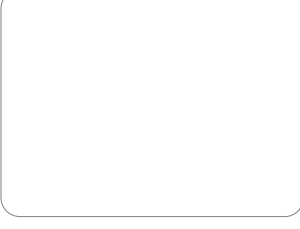
Fixed Address Label	Unique Location Description
	
	
	
	
	

Fixed Address Label	Unique Location Description
	
	
	
	
	

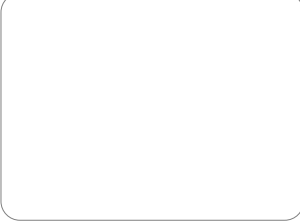
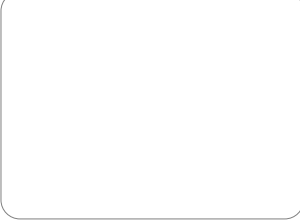
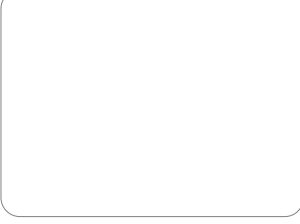
Fixed Address Label	Unique Location Description
	
	
	
	
	

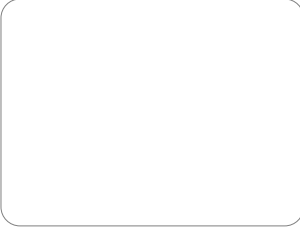
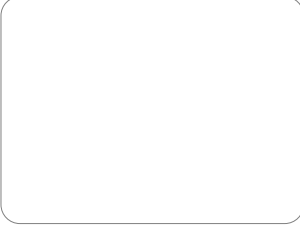
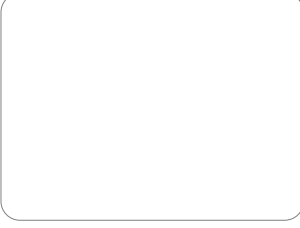
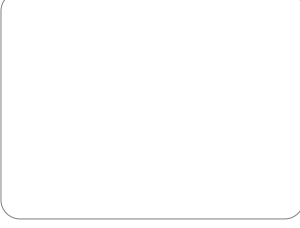
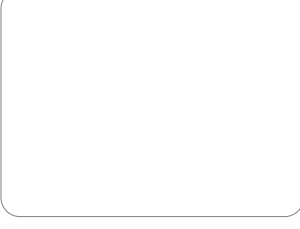
Fixed Address Label	Unique Location Description
	
	
	
	
	

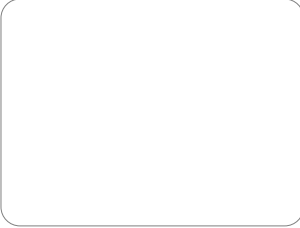
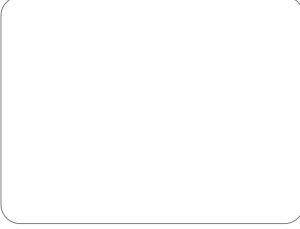
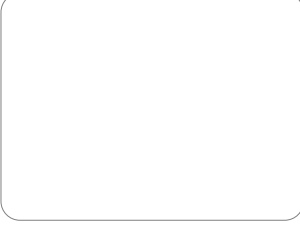
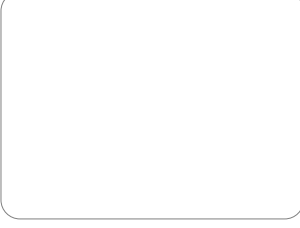
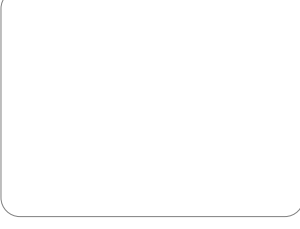
Fixed Address Label	Unique Location Description
	
	
	
	
	

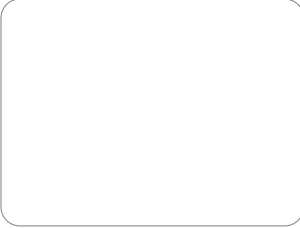
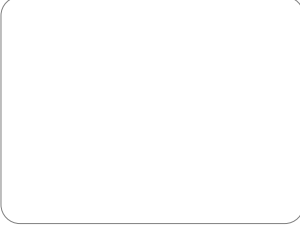
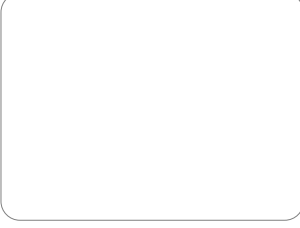
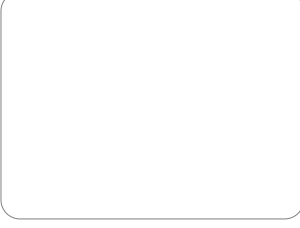
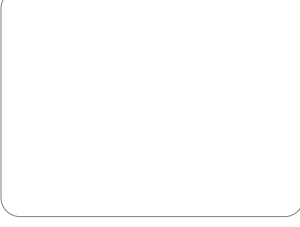
Fixed Address Label	Unique Location Description
	
	
	
	
	

Fixed Address Label	Unique Location Description
	

Table 4: Unit Location Chart

GUARANTEE OR WARRANTY

CAUTION: We reserve the right to nullify the products guarantee or warranty where you have not properly installed the Metal-oxide Varistors.

This product conforms to our Guarantee or Warranty details placed on our Web Site, to read further please go to www.impro.net.

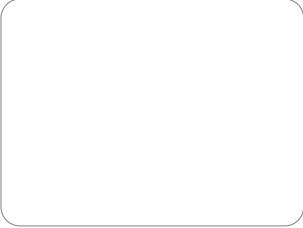
USER NOTES

USER NOTES

USER NOTES

USER NOTES



This manual is applicable to the ImproX IXP220 Controller, ISC960-1-0-GB-01, ISC962-1-0-GB-01, IPS960-1-0-GB-02, IPS961-1-0-GB-02, IPS962-1-0-GB-02 and IPS9631-0-GB-02 and the ImproX GSM Module, GSM900-0-6-GB-00. (The last two digits of the Impro stock code indicate the issue status of the product).

ISC300-0-0-GB-03	Issue 04	Nov 2009	IXP220\Controllor\English Manuals\LATEST ISSUE\IXP220C-inism-en-04.docx
------------------	----------	-------------	--